

「ちきゅう」の特徴

- ・ライザー掘削を採用

 - 泥水循環の採用

 - 噴出防止装置 (BOP)

- ・DPS(Dynamic Positioning System)

- ・大規模な研究設備

- ・海底下地層の柱状試料 (コア) を採取

ライザー掘削システム

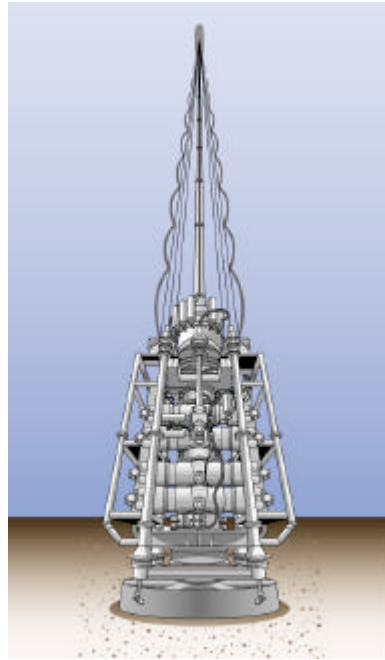

防噴装置
(BOP)

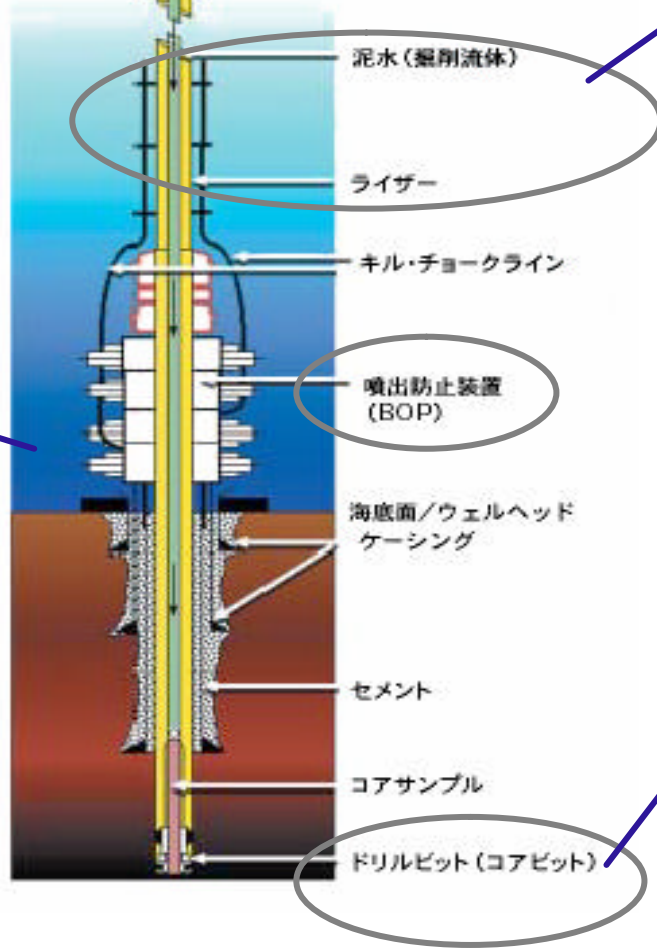

ライザーパイプ

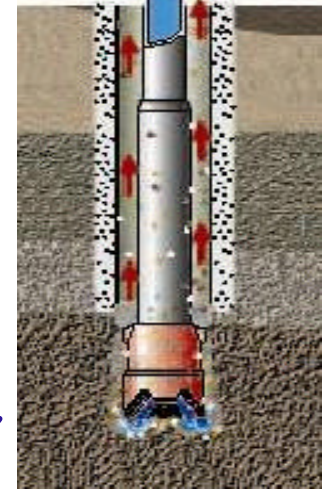
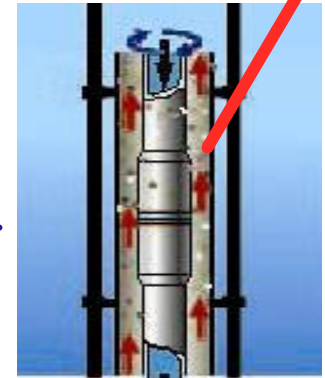

泥水循環

噴出防止装置 (BOP)

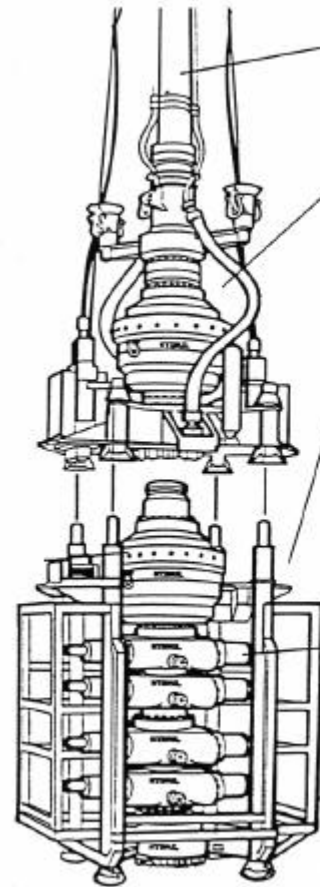
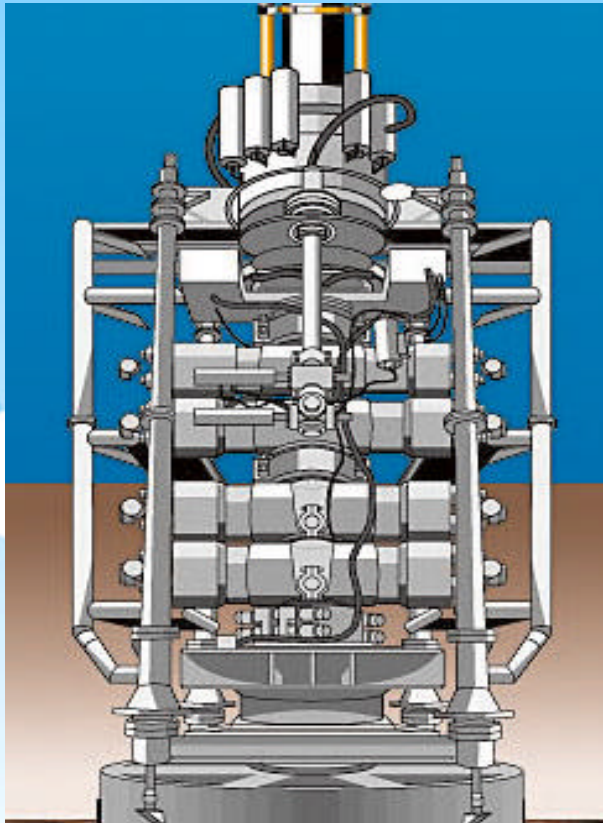

ライザーパイプ

BOP上部/下部 (切り離しが可能)

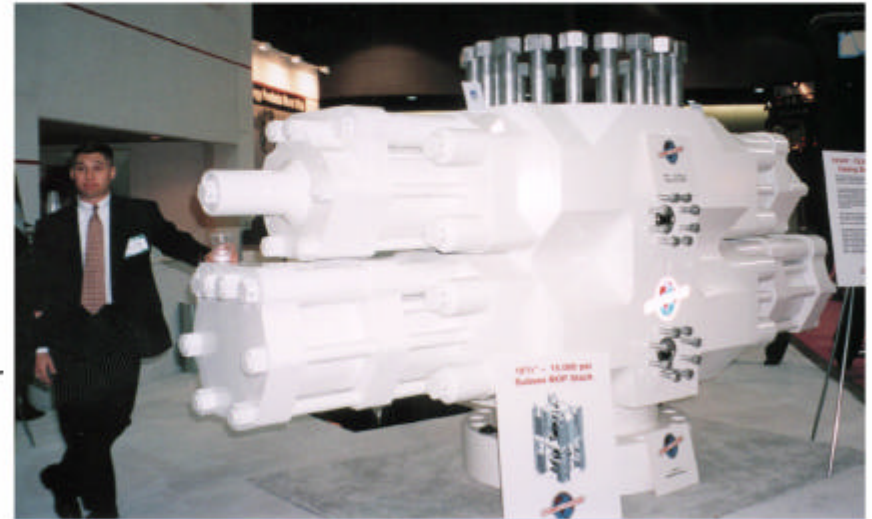

ライザーパイプ

